

ProMaxX 14a

Processed Active Speaker

APPLICATIONS

- Live sound PA system or Live sound monitor, DJ system
- School and corporate audio visual sound reinforcement
- Background music/announcement: Restaurants, Pubs
- Transportation terminals, Clubs, Auditorium, Theatres Gyms, Houses of worship

FEATURES

- 2-way bi-amplified bass reflex design cabinet
- Sturdy gas-injected polypropylene molded enclosure
- 600W RMS LF, 300W RMS HF, class D power amplifiers
- 14" B&C neodymium woofer with 3" voice coil
- 1.4" throat exit B&C neodymium compression driver with 2.5" voice coil
- 90° H x 60° V constant directivity horn
- Digital signal processor with 8 eq. presets
- Control panel with XLR in&link out, Volume, EQ preset, HP filter, GND lift switch
- SPL capability: 135.5dB
- 2 x M10 suspension points
- Dual purpose: Front of house or Stage floor monitor
- Completely Manufactured in Italy



PRODUCT DESCRIPTION

The FBT ProMaxX 14A two-way bi-amplified speaker system shall incorporate a new 14" LF neodymium magnet woofer with 3" voice coil custom made for FBT by B&C and 1.4" exit throat B&C neodymium magnet compression driver with 2.5" voice coil coupled to a 90°H x 60°V constant directivity horn; thanks to the asymmetrical shape also allows use as a stage floor monitor at 12°, 40°, 55°. The FBT ProMaxX 14A shall meet the following performance criteria: Frequency response of 45Hz to 20kHz, Maximum SPL of 135.5dB, 600W RMS + 300W RMS class D power amplifiers with switch mode power supplies. The FBT ProMaxX 14A provides a DSP with 8 factory equalization presets. The FBT ProMaxX 14A feature a sophisticated new cabinet design that increases low frequency SPL; a front face steel grille protects the woofer from external damage. The control panel provides XLR input & link out, Volume, EQ preset, HP filter and GND lift switch. The two M10 fly points built into the cabinet, along with the optional BOX 128 mounting bracket, allow the FBT ProMaxX 14A speaker to be surface mounted on walls or ceilings and a standard 1.38" speaker stand socket allows the FBT ProMaxX 14A to be mounted on speaker stands.

ELECTRICAL PERFORMANCE

System Type	2-way - biamplified
Built-in Amplifiers LF / HF *	cont.: 400W RMS / 200W RMS max.: 600W RMS / 300W RMS peak.: 1200W / 600W
Frequency Response @ -6dB	45Hz - 20kHz
Input Impedance	22kOhm
Maximum SPL (cont. / peak) **	127.5dB / 135.5dB
Dispersion	90° H x 60° V
Crossover Frequency	1.3 kHz
AC Power requirement	640 VA

PHYSICAL

Low Frequency Woofer	1 x 14" - 3" coil
High Frequency Driver	1 x 1.4" - 2.5" coil
Input Connectors	XLR with loop
Net Dimensions (WxHxD)	15.8" x 25.4" x 13.6" 402 x 644 x 345 mm
Shipping Dimensions (WxHxD)	19.7" x 29.3" x 17.3" 500 x 745 x 440 mm
Net Weight	36.4 lbs / 16.5 kg
Shipping Weight	43 lbs / 19.5 kg
Enclosure Material	polypropylene
Power cord	16.4 ft / 5 mt.

* CONT.: 500mS, rms power on nominal speaker impedance
MAX.: 2mS burst, rms power on nominal speaker impedance
MAX PEAK: based on max peak output voltage and nominal speaker impedance

** CONT. SPL: free space, based on continuous power amp rating and LF transducer average sensitivity data, 125mS time average
PEAK SPL: free space, based on max peak power amp rating and system peak sensitivity, 10mS time average



FBT Elettronica s.p.a. - Via Paolo Soprani 1-Zona Ind.le Squartabue - 62019 RECANATI - ITALY
Tel. 071 750591 - Fax 071 7505920 - e.mail: info@fbt.it - www.fbt.it

ProMaxX 14a

Processed Active Speaker

DIAGRAMS

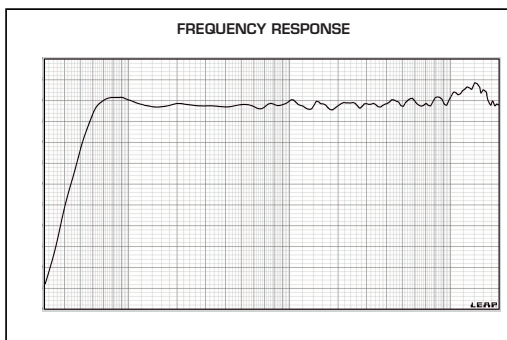
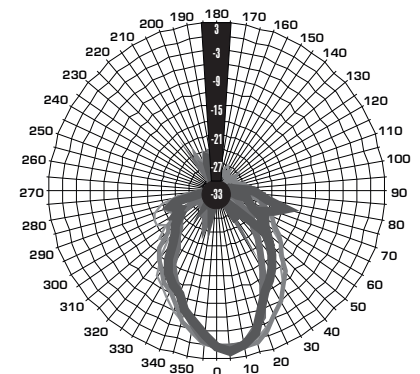
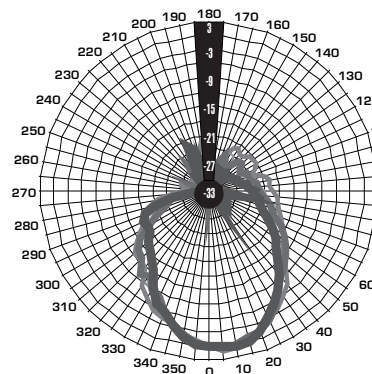
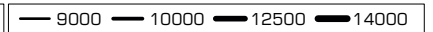
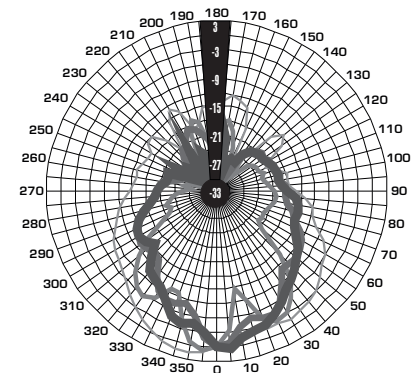
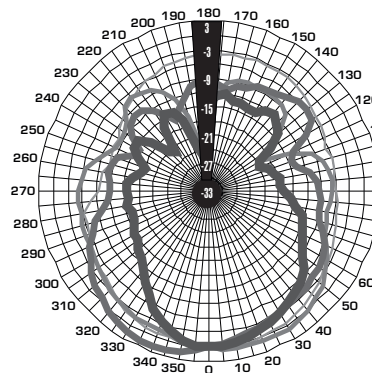
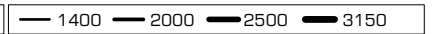
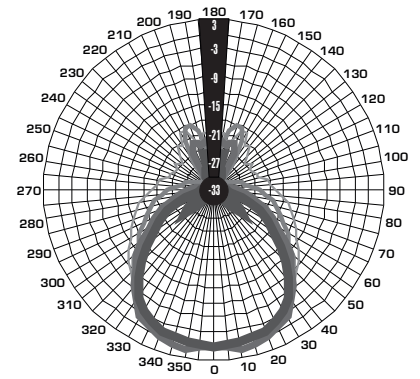
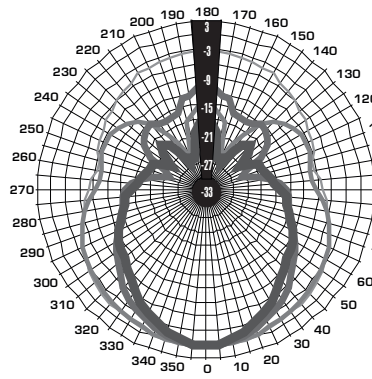
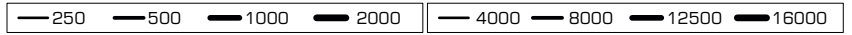
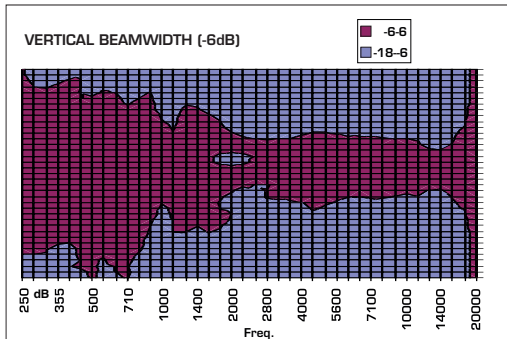
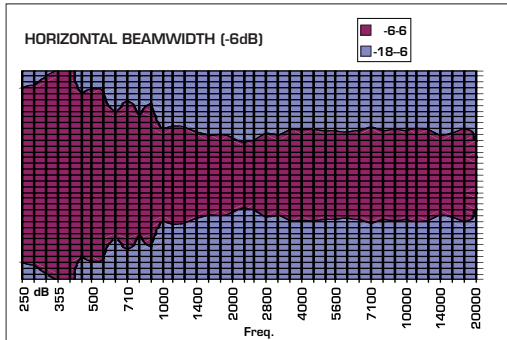

ProMaxX 14a

Processed Active Speaker

ACCESSORIES

BOX 62BK
Adjustable for sub-satellite speaker connection with safety locking device Ø 1.38" M20

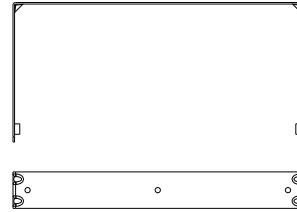

BOX 128
Mount for wall installation

BOX 22BK
Adjustable aluminum floor stand Ø 1.38" with Ø 1" adapter max. weight 88lb.

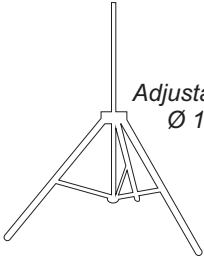

BOX 32BK
Adjustable aluminum floor stand damped safety mechanism max. weight 154lb.

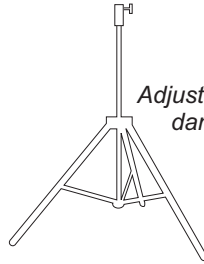

SS2
Standard speaker floor stand Max weight 220 lb.

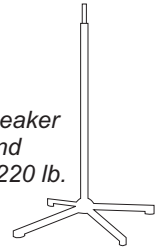

AMPLIFIER MODULE

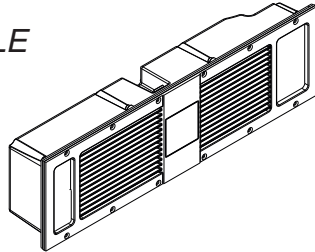

The FBT ProMaxX 14A provides a high efficiency class D power amplifier module with switching power supply enclosed in a die-cast aluminium chassis.

This provides maximum protection of the electronics from dust or dirt, prevents air loss through the input control panel that can cause fastidious noise, and it maximizes heat dissipation avoiding the use of a fan to cool the circuitry.

CONNECTION PANEL

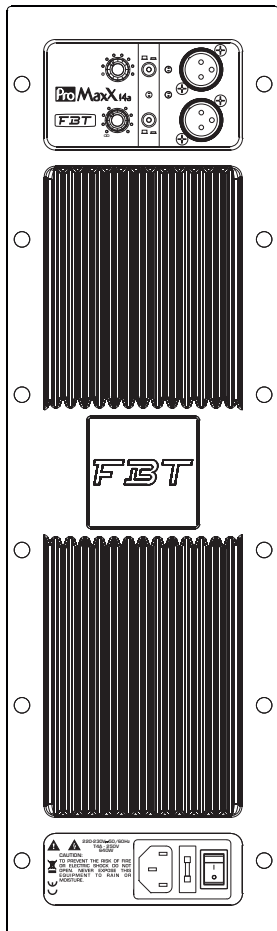

DIMENSION DRAWING

