

HD665 PROFESSIONAL STUDIO HEADPHONES

Description

With HD665's well-defined bass reproduction and clear mid-high sound profile, these professional studio monitoring headphones are perfect for drummers and bass players.

They provide great isolation and drastically reduce levels of external sound reaching a musician's ears, offering valuable protection from potential damage. Self-adjusting headband and foam cushions ensure great fit and maximum comfort. HD665 is great for recording and live situations or playing along with recorded music.

Features

- Well-defined bass reproduction and high resolution character.
- Large, high-performance 40 mm (1.6") drivers provide high sound pressure level and convincing sound.
- Advanced closed-back design ensures high noise reduction.
- Auto-adjustable headband and circumaural design for comfort during long work sessions.



Included

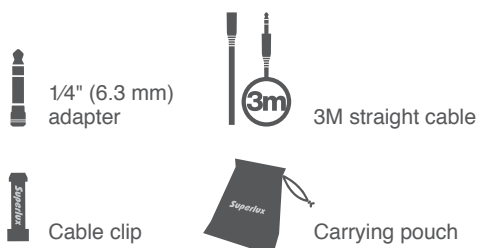

Specifications

Types	Dynamic, Closed-back
Driver	Ø40 mm, Neodymium
Sensitivity	102 dB SPL (1 mW)
Frequency Response	10 - 20,000 Hz
Max. Input Power	200 mW
Rated Impedance	68 Ω (Copper-coated aluminum wire)
Earpads	Leatherette
Cables	3-meter (9.8 ft.) straight, single-sided, plugin cable on headphones (mini stereo connector)
Connector	Gold plated stereo mini plug plus 3.5-6.3 adapter
Finish	White / Black
Weight (w/o cable)	400 g (14.1 oz)

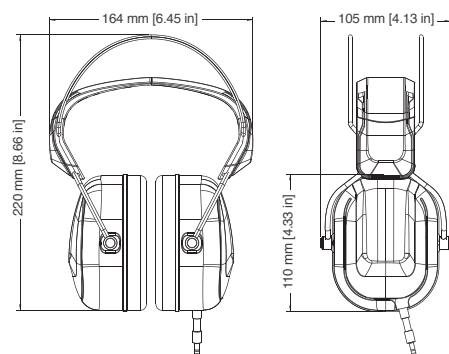

EN

This information sheet contains important information for the safe use of the product. Read and follow the safety and handling instructions given here. Please keep this information sheet for future reference. If you pass on the product described overleaf, please enclose this information sheet.

Safety instructions

Intended use

This device is used for sound reproduction close to the ear in private. Any other use or use under the conditions excluded here is considered improper and can lead to personal injury or property damage. Neither the manufacturer nor the distributor is liable for damage resulting from improper use.

Choking hazard for children

 Make sure that plastic sleeves, packaging, etc. cannot get into the reach of babies and small children. Do not allow children to use electrical devices unsupervised. They could loosen parts of the product, then swallow them and choke on them!

Danger to life from distraction

 The use of earphones or headphones can distract your attention and reduce your perception. Ambient noises will at least be less audible. Never use the device as a participant in traffic or when operating machines.

Possible hearing damage

 The use of earphones or headphones can generate volume levels that can cause temporary or permanent hearing impairment. Do not continuously expose your ears to high volume levels. Stop using the device immediately if you notice ringing in the ears or hearing loss.

Place of operation

The device must not be used



- ▶ at particularly high temperatures or humidity
- ▶ in particularly dusty or polluted places
- ▶ in places where it can be exposed to moisture

General handling

To prevent damage, never use force when handling the product. Never immerse the product in liquids. Just wipe it with a clean, dry cloth. Never use liquid cleaners such as benzene, thinner, or flammable detergents to clean the product.

Disposal

Old devices

 Devices with this label are subject to the current EU directive on waste electrical and electronic equipment (WEEE directive) and may not be  disposed of with household waste, but only via a suitable disposal company. Ask your local authority or your specialist dealer about your options for proper disposal.

Packagings

 Environmentally friendly materials have been selected for the packaging and are to be recycled. Do not just throw away plastic sleeves, packaging, etc., but recycle them. If necessary, note the instructions and labels on the packaging.