

CL3596/CL3596-WH

High-Power 300-Watt, 3-Way, 8 Ω Loudspeaker System with 15" Low-Frequency, 6" Mid-Frequency and 1.35" High-Frequency Transducers



Features

- Professional sound reinforcement loudspeaker system designed for a variety of fixed installation applications
- Exceptional sound quality with wide frequency bandwidth and uniform dispersion
- 250-Watt 15" low-frequency and 75-Watt 6" mid-frequency transducers provide deep bass and precise mid-range for medium to large sized rooms
- Constant directivity 90° H x 60° V rotatable waveguide with 1.35" high-frequency transducer
- Passive crossover with overload circuitry ensures optimal driver protection
- Dual professional speaker connectors (compatible with Neutrik Speakon connectors) and 4-position terminal strip
- Internally braced and acoustically inert 15° trapezoidal birch plywood enclosure ideal for cluster applications
- Multiple threaded inserts for flexible installation including Omnimount™ bolt pattern
- Powder coated steel grille wrapped with acoustically transparent fabric and foam matching cabinet color
- High-quality components and exceptionally rugged construction ensure long life

CL3596/CL3596-WH

High-Power 300-Watt, 3-Way, 8 Ω Loudspeaker System with 15" Low-Frequency, 6" Mid-Frequency and 1.35" High-Frequency Transducers

Product Overview

The EUROCOM CL3596 is a professional high-performance two-way loudspeaker system that is ideal for a wide variety of fixed installation applications. Featuring clean lines and a unique fabric-finished wrap-around grille, the CL3596 is fully at home in even the most elegant settings, including theaters and auditoria, houses of worship, themed entertainment, and sporting venues. Perfect for mains in medium to large venues, the CL3596 also excels for fill and delay systems in large rooms.

Built of high-quality laminated Baltic birch plywood, the CL3596's lightweight cabinet combines natural rigidity and acoustic inertness with the additional strength of internal steel bracing. Threaded mounting-point inserts in the internal brackets provide a rated load factor of at least 10 times overall cabinet weight, making the CL3596 exceptionally safe for flown installation, either singly or in arrays.

The CL3596 achieves fully-professional performance and reliability with newly-designed components whose frequency response, sensitivity, and power handling are all custom-tailored for CL Series loudspeakers. BEHRINGER maintains complete control over quality and sonic character by manufacturing all CL Series components—starting with the pulp used for cone fabrication—in our own factories.

A 15" woofer providing full, rich lows is matched to a 6" mid-range cone driver and a 1.35" compression driver via internal passive crossovers at 600 Hz and 3.8 kHz to deliver clear, smooth sound across the entire audible spectrum. A rotatable waveguide allows optimal application of the 90° x 60° coverage pattern regardless of speaker orientation, which may be either vertical or horizontal. Easy bypass of the crossover offers the added flexibility of operating the loudspeaker in a bi-amped configuration.

Every aspect of the CL3596 has been thought through to maximize value and convenience for both the installer and the end user. The result is an attractive, durable, installation-ready loudspeaker system that will deliver top-notch sound day-after-day for years to come.

Technical Specifications

- Frequency range (-10 dB) 33 Hz - 20 kHz
- Frequency response (± 3 dB) 37 Hz - 18 kHz
- Nominal dispersion 90° H x 60° V
- Directivity factor (Q) 8.7
- Directivity index (DI) 9.4 dB
- Sensitivity (1 W @ 1 m passive) (half space) 97 dB
- Crossover modes Bypassable
- Crossover frequency 600 Hz, 3.8 kHz
- Power handling (long term, IEC passive) 300 W RMS @ 49 V

Transducers:

- Nominal impedance 8 Ω
- Low frequency driver 15" @ 300 W
- Mid frequency driver 6" @ 75 W
- High frequency driver 1.35" @ 30 W
- Maximum continuous SPL (passive) 122 dB
- Maximum peak SPL (passive) 128 dB
- Overload protection Full range power limiting to protect drivers and crossovers
- Enclosure Trapezoidal 15° side angle, laminated birch plywood
- Grille Steel
- Horn waveguide 90° H x 60° V MF/HF, rotatable
- Rigging points 23 x M10 threaded points; 4 x M8 threaded inserts for OmniMount™ 60 series.
- Termination Dual NL4 and 4-position terminal strip connection
- Dimensions (H x W x D) 35.0 x 18.5 x 16.5" / 890 x 470 x 418 mm
- Weight 75.7 lbs / 34.4 kg
- Optional accessories
 - Wall/Ceiling Bracket (Black): CL3500 YB
 - Wall/Ceiling Bracket (White): CL3500 YB-WH
 - Array/Fly Kit for Suspension of (2) Identical CL Series (Black): CL FK
 - Array/Fly Kit for Suspension of (2) Identical CL Series (White): CL FK-WH

CL3596/CL3596-WH

High-Power 300-Watt, 3-Way, 8 Ω Loudspeaker System with 15" Low-Frequency, 6" Mid-Frequency and 1.35" High-Frequency Transducers

Architect's and Engineer's Specifications

Summary description: The loudspeaker shall be a professional 3-way fixed-installation loudspeaker system in a steel-braced plywood enclosure using a bypassable internal crossover network with a 15" / 380 mm low-frequency cone transducer and waveguide-mounted 6" / 150 mm mid-frequency cone driver and 1.35" / 34 mm high-frequency compression driver.

Drivers: The loudspeaker system shall use three transducers:

- Low-frequency driver shall be a 15" / 380 mm direct-radiating cone transducer
- Mid-frequency driver shall be a 6" / 150 mm cone driver mounted in tandem with the high-frequency driver on a rotatable 90° x 60° waveguide constructed of polypropylene
- High-frequency driver shall be a 1.35" / 34 mm diaphragm compression driver mounted in tandem with the mid-frequency driver on a rotatable 90° x 60° waveguide constructed of polypropylene

Enclosure: The loudspeaker system shall be housed in an enclosure constructed of laminated birch plywood that is internally braced with steel. The enclosure shall be finished with durable, scuff-free black or white paint. The front of the enclosure shall be protected with a perforated grille of powder-coated structural steel behind fabric-wrapped acoustically transparent foam. The back of the enclosure shall have a recessed steel input plate for connectors.

Rigging and mounting: The exterior of the enclosure shall be fitted with 23 M10 threaded rigging points. The rear of the enclosure shall have 4 M8 threaded inserts for OmniMount™ 60 bolts. The enclosure shall provide attachment points for an optional yoke bracket.

I/O and connectors: The loudspeaker system shall have the following connectors:

- Two NL4 connectors, wired in parallel as full-range inputs to the passive crossover
- One 4-position terminal strip with captive wire clamps and removable plastic cover, with IN terminals wired in parallel to OUT terminals and to the NL4 connectors
- Crossover bypass as a detachable connector on the crossover PCB, allowing direct connection to each driver

Performance criteria: The loudspeaker system shall meet the following performance criteria:

- Nominal impedance shall be 8 Ω
- Sensitivity (1 W / 1 m passive) shall be 97 dB
- Usable frequency range (-10 dB) shall be 33 Hz - 20 kHz
- Frequency response (± 3 dB) shall be 37 Hz - 18 kHz
- Power Handling (IEC268-5, passive) shall be 300 W RMS @ 40 V
- Nominal dispersion shall be 90° x 60° (axis dependent on horn orientation)
- Maximum SPL (1 m, passive) shall be 122 dB continuous and 128 dB peak

Dimensions and weight: The loudspeaker system shall have the following physical characteristics:

- Height shall be 35.0" / 890 mm
- Width shall be 18.5" / 470 mm
- Depth shall be 16.5" / 418 mm
- Net Weight shall be no more than 75.7 lbs / 34.4 kg

Model: The loudspeaker shall be the BEHRINGER EUROCOM CL3596/CL3596-WH.



CL3596/CL3596-WH

High-Power 300-Watt, 3-Way, 8 Ω Loudspeaker System with 15" Low-Frequency, 6" Mid-Frequency and 1.35" High-Frequency Transducers

Beamwidth VS. Frequency

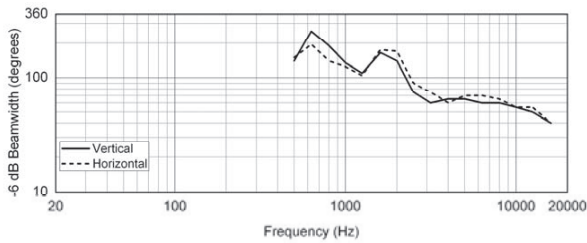

Vertical Up Off-Axis Frequency Response

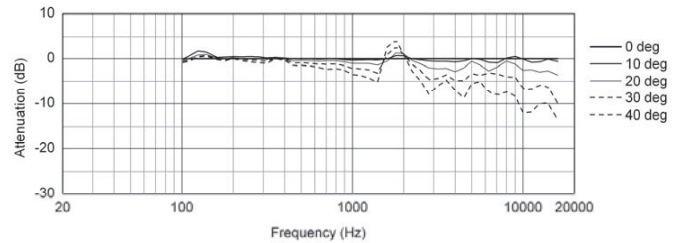

Horizontal Off-Axis Frequency Response

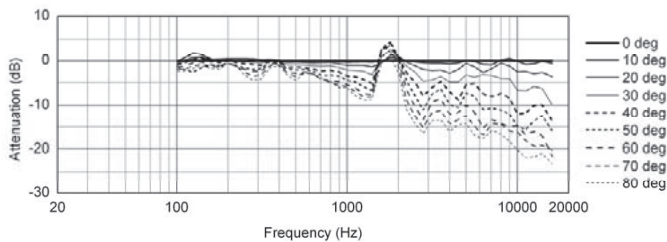

Vertical Down Off-Axis Frequency Response

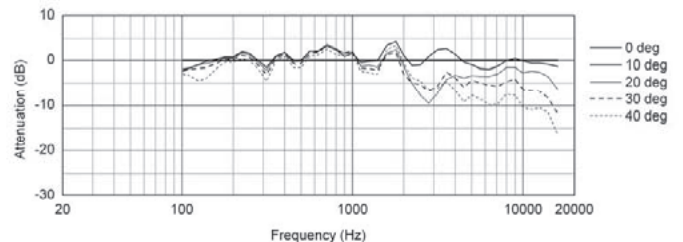

Frequency Response, 1 W @ 1 M

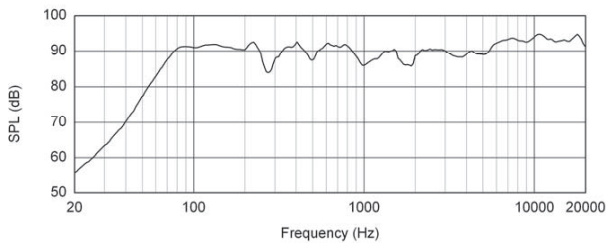

Impedance VS. Frequency

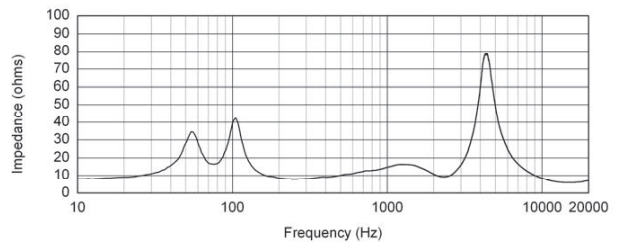

Directivity Index, Q

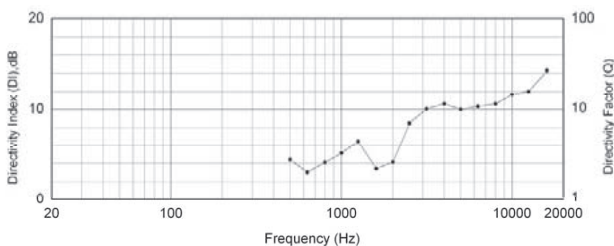

CL3596/CL3596-WH

High-Power 300-Watt, 3-Way, 8 Ω Loudspeaker System with 15" Low-Frequency, 6" Mid-Frequency and 1.35" High-Frequency Transducers

Horizontal 1/3 Octave Polars

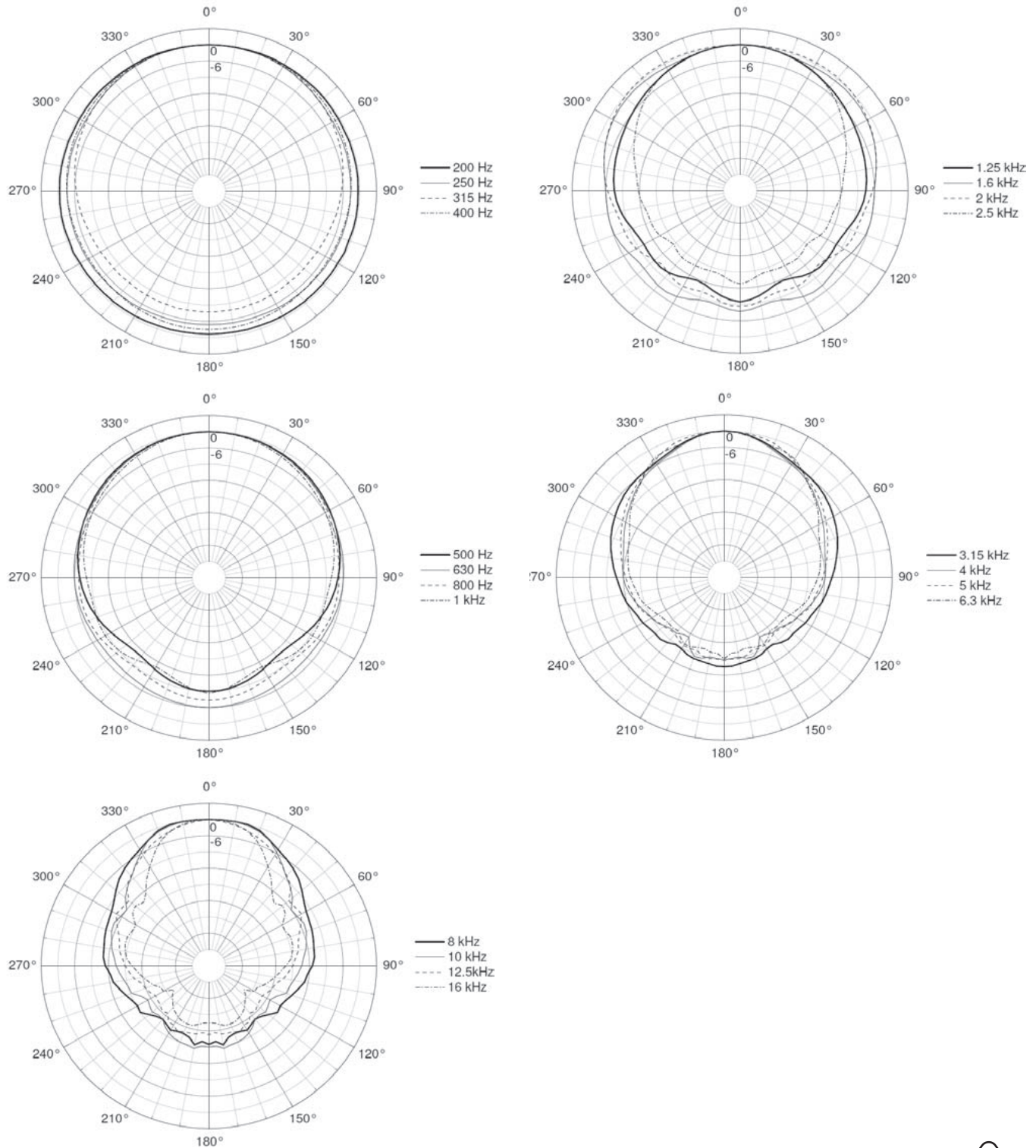

CL3596/CL3596-WH

High-Power 300-Watt, 3-Way, 8 Ω Loudspeaker System with 15" Low-Frequency, 6" Mid-Frequency and 1.35" High-Frequency Transducers

Vertical 1/3 Octave Polars

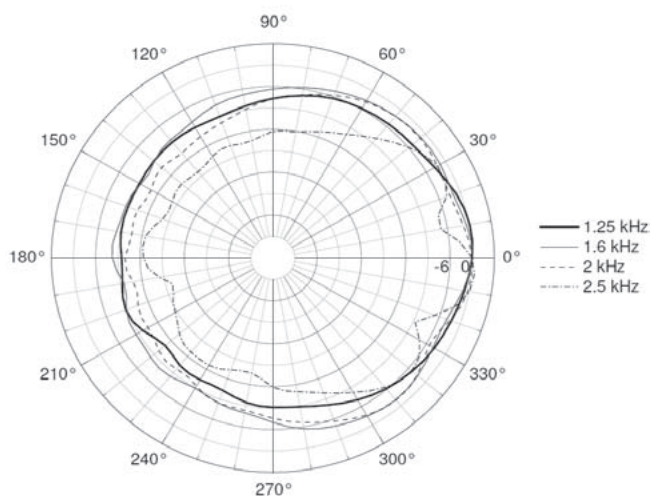
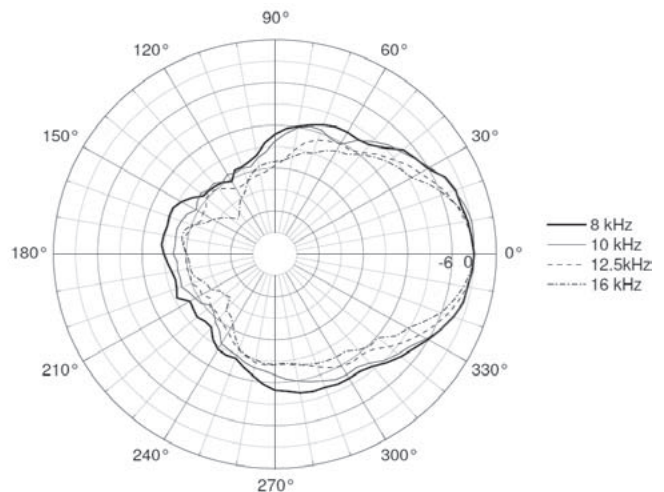
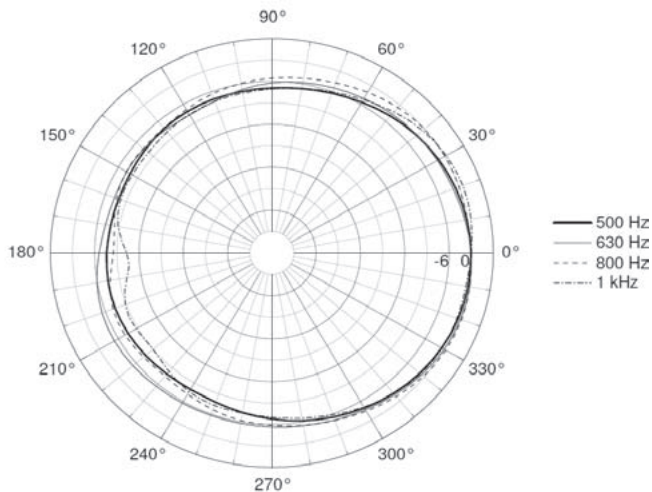
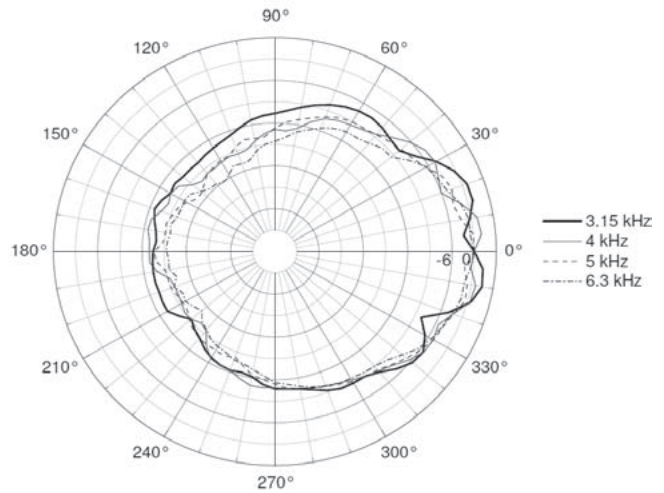
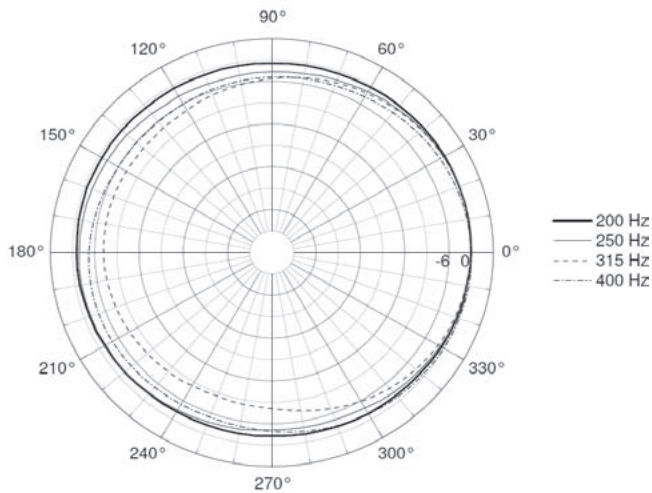

CL3596/CL3596-WH

High-Power 300-Watt, 3-Way, 8 Ω Loudspeaker System with 15" Low-Frequency, 6" Mid-Frequency and 1.35" High-Frequency Transducers

Dimensional Drawings

