

DesignMax DM3SE

surface-mounted loudspeaker

Product Overview

DesignMax loudspeakers bring outstanding audio and aesthetics to any commercial space. The 25-watt DesignMax DM3SE loudspeaker features a two-way 3.25-inch woofer and ¾-inch tweeter coaxially mounted within the Dispersion Alignment system, producing a frequency range of 75 Hz - 20 kHz. And with both black and white versions available, DesignMax loudspeakers integrate seamlessly with any décor.



Key Features

Deliver instantly impressive sound with custom Bose drivers — no DSP or EQ required. For even better sound, use select Bose DSPs and amplifiers to enable Bose loudspeaker EQ and SmartBass processing, which expands performance and response at any listening level

Ensure a consistent listening experience throughout the room with the Dispersion Alignment system, which matches the coverage of the woofer to the pattern of the tweeter

Blend into any room design with elegant form factors, minimum-bezel grilles available in black or white, and removable logos

Reduce installation time with the patented QuickHold mounting system, which also reduces strain, hassle, and the chance of product damage

Install easily — includes Euroblock connectors that make installation and troubleshooting easier

Install DM3SE outside — IP55 rating with standard aluminum grille for outdoor use

Technical Specifications

SINGLE LOUSPEAKER PERFORMANCE		
Frequency Response (-3 dB) ⁽¹⁾	85 - 20,000 Hz	
Frequency Range (-10 dB) ⁽¹⁾	75 - 20,000 Hz	
Nominal Coverage (H x V) ⁽²⁾	140° x 140°	
Nominal Coverage Angle (1 - 10 kHz)	135° x 135°	
	Bose extended-lifecycle test ⁽⁵⁾	AES component test ⁽⁶⁾
Power Handling, long-term continuous	25 W	30 W
Power Handling, peak	100 W	120 W
Sensitivity (SPL / 1 W @ 1m) ⁽³⁾	84 dB	84 dB
Calculated Maximum SPL @ 1 m ⁽⁴⁾	98 dB	99 dB
Calculated Maximum SPL @ 1 m, peak	104 dB	105 dB
Crossover	1.7 kHz (passive 2-way crossover)	
Loudspeaker EQ	Not Required, Bose EQ voicing and SmartBass Processing available	
Recommended High-Pass Protection	80 Hz with recommended 24 dB / octave filter	
Transformer taps	70V: 3, 6, 12, 25 W, bypass 100V: 6, 12, 25 W, bypass	
TRANSDUCERS		
Low Frequency	1 x 83 mm woofer (3.25 in), weather-treated	
High Frequency	1 x 20 mm (0.75 in) neodymium dome tweeter, coaxially mounted, weather-treated	
Technology	Dispersion Alignment System, 127 mm (5 in) system diameter	
Nominal Impedance	8 ohms (transformer bypass)	

DesignMax DM3SE

surface-mounted loudspeaker

PHYSICAL	
Enclosure Material	Engineered plastics, highly UV fade resistant
Bracket Material	Powder-coated steel
Grille	Perforated aluminum with a powder coat finish, tamper-resistant design, paintable
Logo	Rotatable, removable
Color	Black: RAL 9005, White: Bose Arctic White, similar to RAL 9003, Paintable
Environmental / Ingress-Protection	Outdoor per IEC 529 IP55 (suitable for use outdoors in wet locations), includes aluminum grille to prevent red corrosion and weather resistant input cover
Safety Agency	UL-1480A, S5591/ UL Listed, NFPA70, in accordance with IEC60268-5, ROHS, CE compliant
Operating Temperature Range	-25 °C to 70 °C (-13 °F to 158 °F)
Connectors	Euroblock 6-pin connector with loop-through, mounted on rear. Accepts 18 AWG (0.8 mm ²) to 14 AWG (2.5 mm ²) size wire
Suspension / Mounting	QuickHold Mounting System with included U-Bracket
	4 preset mounting angles: 0°, 15°, 30°, 45° for wall or ceiling placement
	Two (2) rear M6 screw inserts for use with optional pan & tilt bracket and one (1) rear M6 screw insert for safety-tether attachment
Dimensions (H x W x D)	232 x 154 x 156 mm (9.1 x 6.1 x 6.1 in)
Dimensions with Bracket (H x W x D)	232 x 154 x 172 mm (9.1 x 6.1 x 6.8 in)
Net Weight, Loudspeaker with grille (single)	2.8 kg (6.1 lb)
Shipping Weight (pair)	7.2 kg (16.0 lbs)
Included Accessories	U-Bracket, powder-coated steel
Optional Accessories	Pan & Tilt Bracket
PRODUCT CODE	
829712-0110	DESIGNMAX DM3SE PAIR BLK
829712-0210	DESIGNMAX DM3SE PAIR WHT

Footnotes

- (1) Frequency response and range measured on-axis in half-space environment with Bose EQ voicing
- (2) 1 kHz to 4kHz average
- (3) Sensitivity measured on-axis in half-space environment with Bose EQ voicing
- (4) Maximum SPL calculated from sensitivity and power handling specifications, exclusive of power compression.
- (5) Bose extended-lifecycle test using pink noise filtered to meet IEC268-5, 6-dB crest factor, 500-hour duration.
- (6) AES standard 2-hour duration with IEC system noise

For additional specifications and application information, please visit PRO.BOSE.COM.
Specifications subject to change without notice. 11/2019

DesignMax DM3SE

surface-mounted loudspeaker

On-Axis Frequency Response (half-space (2π) with Bose EQ voicing)

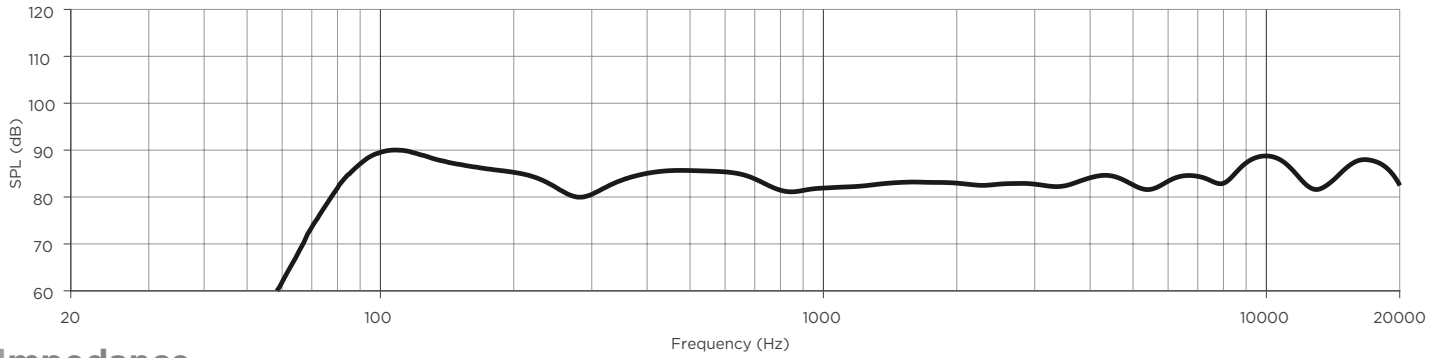

Impedance

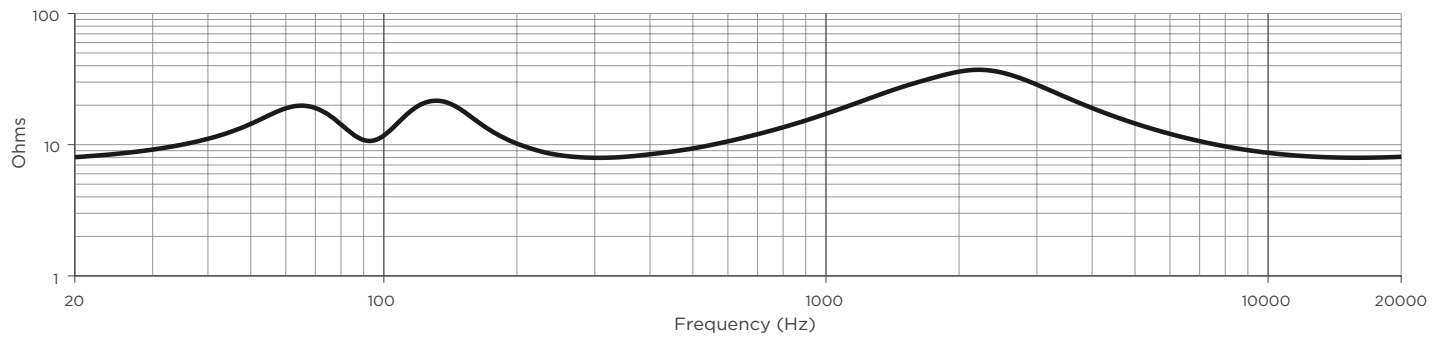

Beamwidth

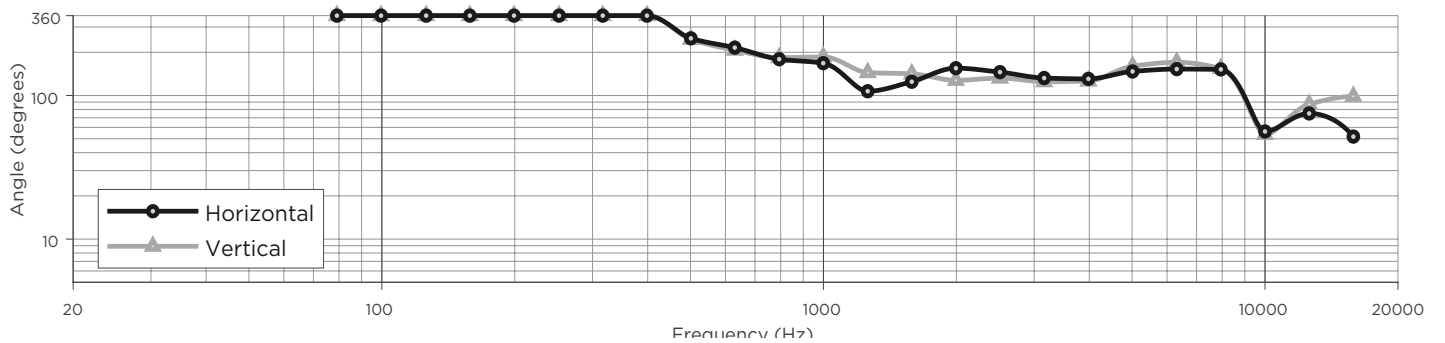

For additional specifications and application information, please visit PRO.BOSE.COM. Specifications subject to change without notice. 11/2019

DesignMax DM3SE

surface-mounted loudspeaker

Dimensions

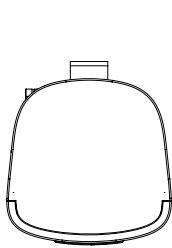

Top View

LOCK FORK

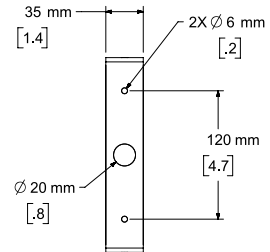
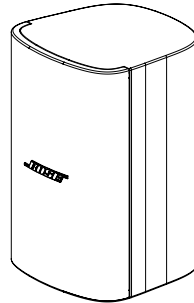

Rear View
BRACKET ONLY

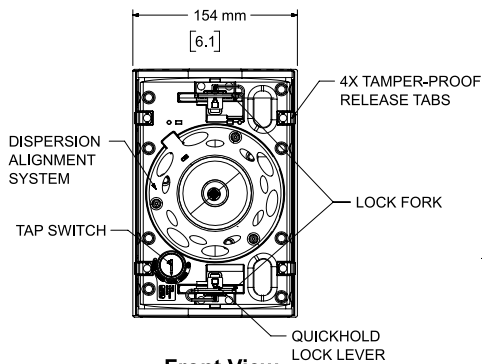

Front View
GRILLE REMOVED FOR CLARITY

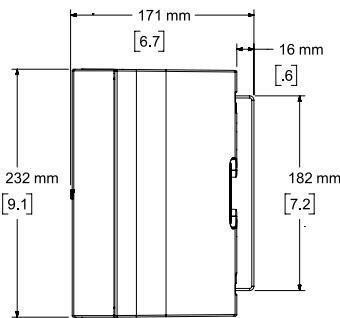

Right View
DIMENSIONS APPLY TO BOTH SIDES

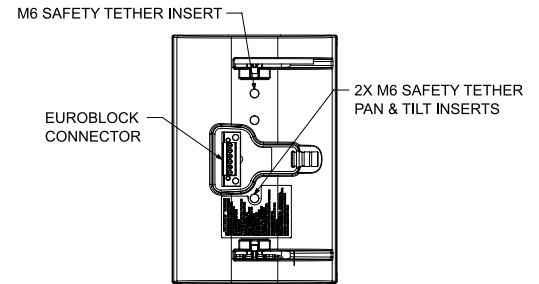

Rear View
BRACKET/INPUT COVER REMOVED FOR CLARITY

- NOTES:
1. DIMENSIONS ARE IN MILLIMETERS OVER INCHES
 2. WEIGHT 2.5kg [5.6lbs] (SPEAKER ONLY)
WEIGHT W/BRACKET 2.8kg [6.1lbs]

For additional specifications and application information, please visit PRO.BOSE.COM.
Specifications subject to change without notice. 11/2019